

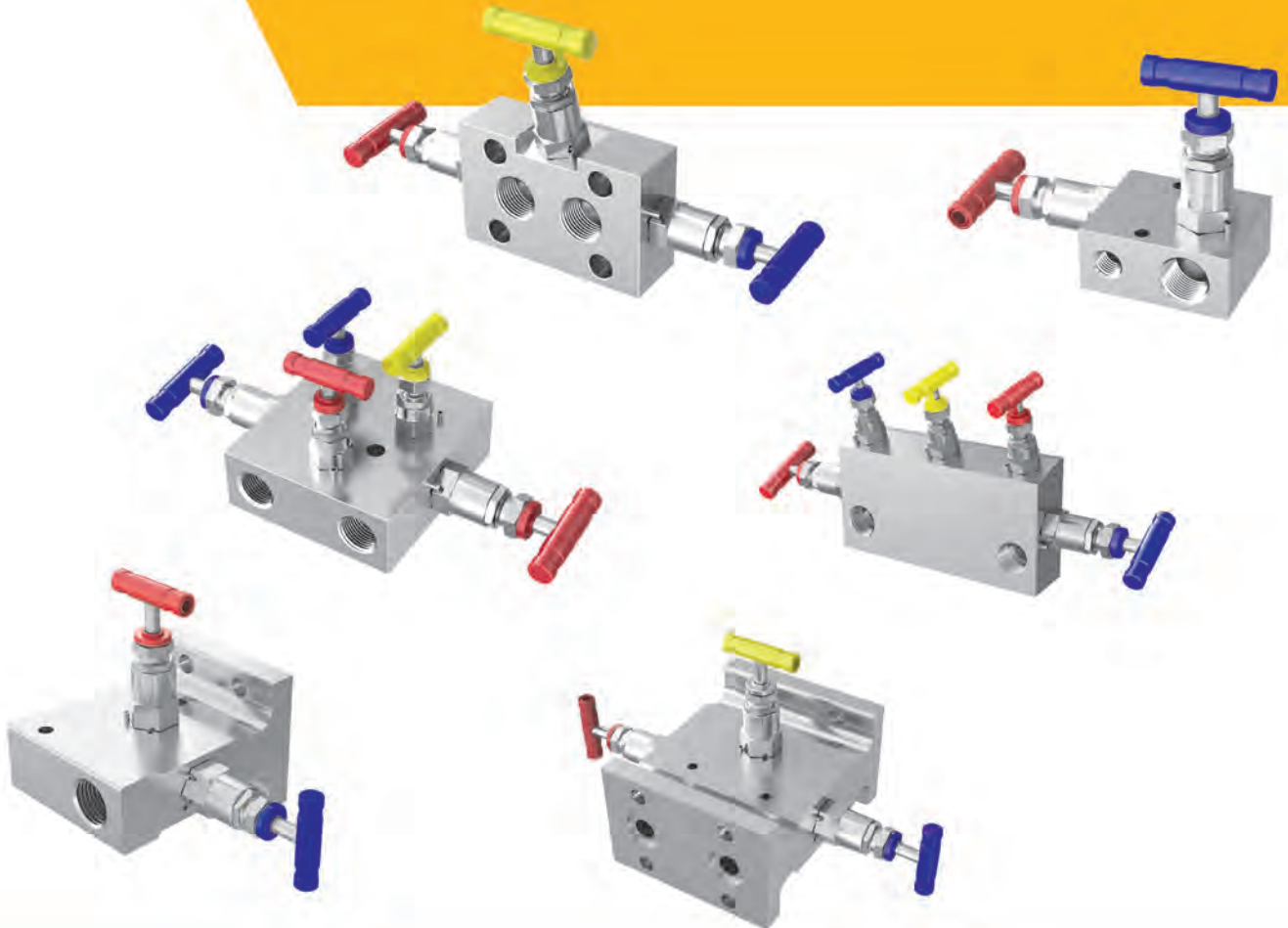

XYF-JFG 系列 仪表阀组

XYF - JFG series Instrument Manifolds



SINYA





目 录



CONTENT



2阀组 2-valve manifolds



 07  -JFG2A-LW8-D



 07  -JFG2A-LW8-R



 07  -JFG2B1-LW4-R

 08  -JFG2B2-LW8-R

 08  -JFG2B3-LW4-R



 08  -JFG2B4-LW8-R



 09  -JFG2T1-LW8-D



 09  -JFG2T2-LW8-D

 10  -JFG2F-LW-D



3阀组 3-valve manifolds



 10  -JFG3A1-LW8-R



 10  -JFG3A2-SK8-R



 11  -JFG3A3-LW8-R



 11  -JFG3A4-GH12mm-R



 11  -JFG3B1-LW8-D

 11  -JFG3B2-SK6-D

 12  -JFG3B3-LW8-D

 12  -JFG3B4-SK6-D



 12  -JFG3C1-LW8-D

 12  -JFG3C2-SK8-D

 12  -JFG3T-LW8-D

 13  -JFG3G-FG-D

5阀组 5-valve manifolds

 13  -JFG5A1-LW8-R



 13  -JFG5A2-SK8-R



 14  -JFG5C1-LW8-D



 14  -JFG5C1-SK8-D



 14  -JFG5C2-LW8-R



 14  -JFG5C2-SK8-R

 14  -JFG5C3-LW8-D

 14  -JFG5C3-SK8-D

 14  -JFG5C3-SK8-D

 15  -JFG5C4-LW8-R

 15  -JFG5C4-SK8-R

 15  -JFG5T1-LW8-D

 15  -JFG5T1-SK12mm-D

 15  -JFG5G-FG-D

XYF — JFGseries Instrument Manifolds

● 产品概述

XYF-JFG系列仪表阀组汇集国内外各种压力、差压、流量、液位物位等变送器设计成供静压和液位压力用途使用。3和5阀组为差压用途所设计。结构形式和端接方式多种多样，供设计、安装、使用单位选型。该系列仪表阀组广泛应用于炼油、化工、电力、煤制氢、冶金、核电等工程项目中。

● 阀门特点

由一组不锈钢针阀加以控制，每一组阀门具体的功能—阻断压力，排放压力或平衡压力—视其在阀组上的位置而定。

所有这些功能的控制由两种针阀设计来承担，大阀盖针阀适用于0.156in (4.0mm) 口径的阀组，小阀盖针阀适用于0.125in (3.2mm) 口径的阀组。

在两种设计上，阀杆填料在开启或关闭位置从外面可以调整，PTFE是标准填料，也可供应柔性石墨填料供高温场合使用。

● Product Features

XYF-JFG series instrument manifolds are used for static & hydraulic pressure based on the transmitters for pressure, differential pressure, flow rate, liquid level and etc at home and abroad. 3-valve & 5-valve manifolds are designed for differential pressure. There are many kinds of structure types and end connections for model selection. All the instrument manifolds have been widely used in engineer projects of oil refining, chemical industry, electrics, coal-to-hydroxide, metallurgy, nuclear power and so on.

● Valve Features

Controlled by a group of needle valves made of stainless steel. The function of each valve (pressure-shutting off, pressure drainage or pressure balancing) is determined by its definite position on the manifolds. All these functions are undertaken by two kinds of needle valves: needle valves with big bonnet are used for the manifolds with nominal diameter of 0.156in(4.0mm), and needle valves with small bonnet are used for the manifolds with nominal diameter of 0.125in (3.2mm).



● 阀组结构特点

- 系列阀组设计成供静压和液位使用的2阀组。供差压使用的有3阀组、5阀组两种。
- 系列阀组为卧式主体设计、阀组连接件的选择1/2in和Φ12mm卡套管接头，1/2in内螺纹（NPT和ISO228/1）和法兰（MSS SP-99）。

◎ 法兰设计的选择符合MSS SP-99的要求。

◎ 法兰密封件和法兰螺栓与阀组一并提供。

□ 阀盖与阀体密封后配作不锈钢销，防止振动而脱离阀体。

□ 阀体与阀盖由金属对金属密封不需要密封填料。

□ 一体化结构设计，增加强度。

□ 中心孔尺寸21/8in（54mm）便于带法兰连接的直接仪表对准。

□ 使用内螺纹管接头和NPT螺纹接头进行远程安装。

● Structure Features of Manifolds

● Series valve manifolds are designed as 2-valve manifolds for static pressure and liquid level. 3-valve & 5-valve are designed for differential pressure.

● Series valve manifolds are designed to be of horizontal type. The tube fittings of 1/2in & Φ12mm are used for manifolds connection by 1/2 in female and flange (MSS SP-99).

The flange selected should meet the requirements in MSS SP-99.

The flange sealing and bolts should be supplied at the same time

□ Stainless steel pins are supplied accordingly between the bonnet and the valve sealing to prevent the bonnet dropping from the body.

□ Sealing gasket is not necessary since the body and the bonnet are sealed by metal to metal sealing.

□ One-piece designing can increase the strength.

□ The size of the center hole 2-1/8" (54mm) is convenient for the instrument calibrating with flange connection.

□ Female tube fittings and NPT thread fittings are used for long-distance installation.

XYF — JFGseries Instrument Manifolds

● 技术数据

- ◎ 不锈钢阀组工作压力6000PSI (413bar)。
- ◎ 标准PTFE填料工作温度-54 ~ 232°C(-65 ~ 450 °F)
- ◎ 标准石墨填料工作温度-54 ~ 649°C(-65 ~ 1200 °F)
- ◎ 标准碳氟FKM工作温度-28 ~ 232°C(-20 ~ 450 °F)
- ◎ 阀门内通径0.125in (3.2mm)、0.156in (4.0mm)

● Technical Data

- ◎ Operating pressure of stainless steel manifolds would be 6000psi (413bar).
- ◎ Operating temperature of standard PTFE would be -54 ~ 232°C (-65 ~ 450 °F)
- ◎ Operating temperature of standard graphite would be -54 ~ 649 °C(-65 ~ 1200 °F)
- ◎ Operating temperature of standard carbon fluorine FKM would be -28 ~ 232 °C(-20 ~ 450 °F)
- ◎ Inner nominal diameter of the valve would be 0.125in (3.2mm), 0.156in (4.0mm).

● 压力等级 Pressure Class

材料名称 Material 温度°F (°C) Temperature	316SS 工作压力Operating pressure psi (bar)	材料名称 Material 温度°F (°C) Temperature	316SS 工作压力Operating pressure psi (bar)
-65 (-53) 至100 (37)	6000 (413)	750 (398)	3520 (242)
200 (93)	5160 (355)	800 (426)	3460 (238)
250 (121)	4910 (338)	850 (454)	3380 (232)
300 (148)	4660 (321)	900 (482)	3280 (225)
350 (176)	4470 (307)	950 (510)	3220 (221)
400 (204)	4280 (294)	1000 (537)	3030 (208)
450 (232)	4130 (284)	1050 (565)	3000 (206)
500 (260)	3980 (274)	1100 (593)	2685 (148)
500 (260)	3870 (266)	1150 (621)	2285 (157)
600 (315)	3760 (259)	1200 (648)	1715 (118)
650 (343)	3700 (254)	—	—
700 (371)	3600 (248)	—	—

● 阀组选型指南 Order information for Manifolds



1=材料material	
S	碳钢 carbon steel
SS	316不锈钢 stainless steel
SS1	321不锈钢 stainless steel
SS2	304不锈钢 stainless steel
HC	合金C-276 alloy
M	合金400/R-405 alloy
INC	合金600 alloy
Ti	钛合金 Titanium alloy

2=阀组系列Manifolds series	
JFG	阀组系列 manifolds series

3=阀组代号manifolds code	
2	二阀组 2-valve manifold
3	三阀组 3-valve manifold
5	五阀组 5-valve manifold

4=阀组形式manifolds type	
A	水平 horizontal
B	直角 Right angle
C	直线 Straight line
T	T型 T-type
G	工字型 I-shaped
F	法兰型 Flange type

5=过程接口process interface	
SK	卡套 ferrule
LW	螺纹 thread
GH	对焊 butt welding
FG	法兰 flange

6=尺寸size	
4	1/4in英寸
6	3/8in英寸
8	1/2in英寸
6mm	6mm毫米
8mm	8mm毫米
10mm	10mm毫米
12mm	12mm毫米

7=仪表连接instrument connection	
D	共面法兰 coplanar flanges
R	远程安装 long-distance installation

● 备注

- ◎ 必备附件与变送器配套螺栓和密封环。
- ◎ 标准螺栓为7/16-20碳钢材料镀锌黄，可提供其它材料。
- ◎ 标准密封环材料为聚四氟乙烯（PTFE），可提供石墨材料。
- ◎ 选型时注明螺栓长度或提供变送器品牌和型号。

型号Model: SS-JFG3A-SK8-D	
SS	316 SS不锈钢
JFG	阀组系列 Manifold series
3	三阀组 3-valve manifold
A	水平型式 horizontal
SK	双卡套 double ferrule
8	接头尺寸1/2英寸 Tube fitting size
D	共面法兰 coplanar flange

● Remark:

- ◎ The necessities would be the bolts and the sealing ring for transmitters.
- ◎ Standard bolts would be 7/16-20 of carbon steel zinc-plated, or made of some other materials specified.
- ◎ Standard sealing ring would be made of PTFE, also can be of graphite.
- ◎ Please indicate the bolt length or the transmitter brand and model while ordering.

型号Model: M-JFG3T-LW8-D	
M	合金Alloy 400/R-405
JFG	阀组系列 Manifold series
3	三阀组 3-valve manifold
LW	螺纹 thread
8	1/2 in 英寸
D	共面法兰 coplanar flange

XYF-JFG系列仪表阀组



XYF — JFGseries Instrument Manifolds

2阀组 valve manifolds

基本订货号 Order information	入口/过程接口 inlet/process interface	出口/仪表 outlet/instrument	测试口/泄放口 measuring port/drainage port
-JFG2A-LW8-D	1/2"NPT阴螺纹	共面法兰 coplanar flange	1/4"NPT阴螺纹 female

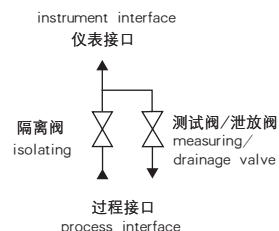
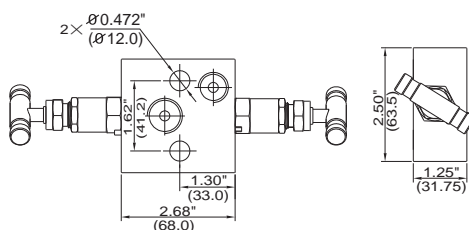

配有1个聚四氟乙烯密封环和2个7/16"UNF高强度螺栓

One PTFE sealing ring and two 7/16" UNF bolts with high strength are supplied accordingly.

基本订货号 Order information	入口/过程接口 inlet/process interface	出口/仪表 outlet/instrument	测试口/泄放口 measuring port/drainage port
-JFG2A-LW8-R	1/2"NPT阴螺纹female	1/2"NPT阴螺纹female	1/4"NPT阴螺纹female

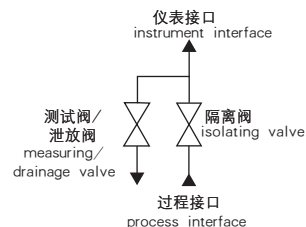
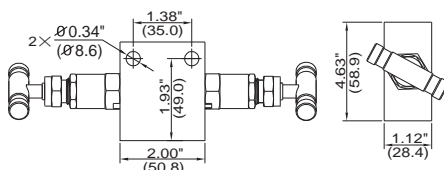

基本订货号 Order information	入口/过程接口 inlet/process interface	出口/仪表 outlet/instrument	测试口/泄放口 measuring port/drainage port
-JFG2B1-LW4-R	1/4"NPT阴螺纹female	1/4"NPT阴螺纹female	1/4"NPT阴螺纹female

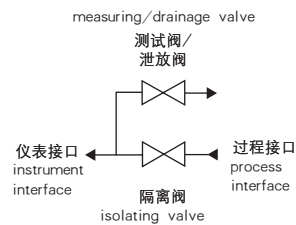
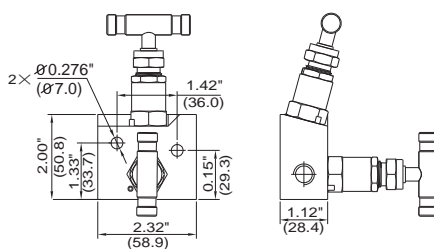

扬中新亚自控工程有限公司

YANGZHONG SINYA AUTO-CONTROL ENGINEERING CO.,LTD.

基本订货号 Order information	入口/过程接口 inlet/process interface	出口/仪表 outlet/instrument	测试口/泄放口 measuring port/drainage port
-JFG2B2-LW8-R	1/2"NPT 阴螺纹 female	1/2"NPT 阴螺纹 female	1/4"NPT 阴螺纹 female

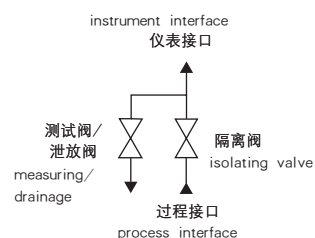
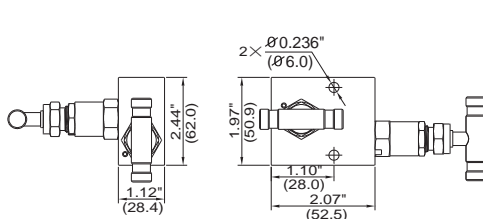

基本订货号 Order information	入口/过程接口 inlet/process interface	出口/仪表 outlet/instrument	测试口/泄放口 measuring port/drainage port
-JFG2B3-LW4-R	1/4"NPT 阴螺纹 female	1/4"NPT 阴螺纹 female	1/4"NPT 阴螺纹 female

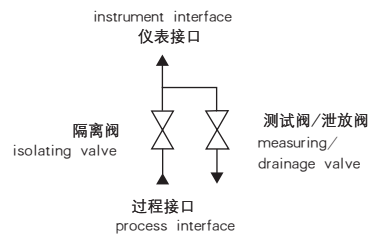
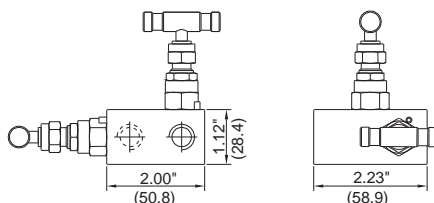

基本订货号 Order information	入口/过程接口 inlet/process interface	出口/仪表 outlet/instrument	测试口/泄放口 measuring port/drainage port
-JFG2B4-LW8-R	1/2"NPT 阳螺纹 Male	1/2"NPT 阳螺纹 Male	1/4"NPT 阴螺纹 female

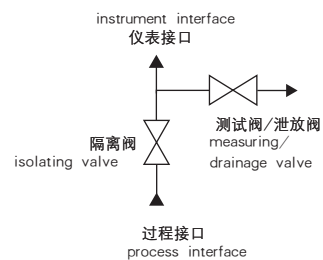
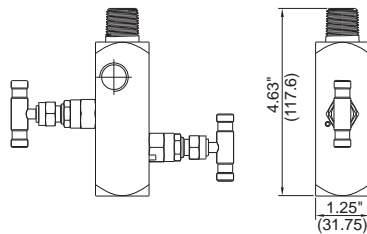

XYF-JFG系列仪表阀组



XYF — JFGseries Instrument Manifolds

基本订货号 Order information	入口/过程接口 inlet/process interface	出口/仪表 outlet/instrument	测试口/泄放口 measuring port/drainage port
-JFG2T1-LW8-D	1/2"NPT阴螺纹 female	共面法兰 coplanar flange	1/4"NPT阴螺纹female

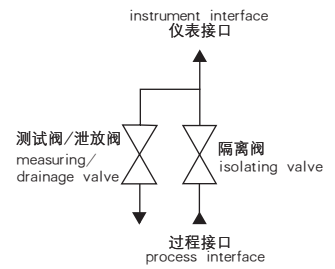
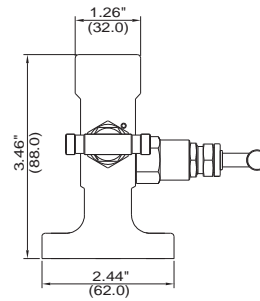
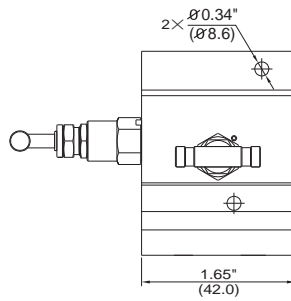

基本订货号 Order information	入口/过程接口 inlet/process interface	出口/仪表 outlet/instrument	测试口/泄放口 measuring port/drainage port
-JFG2T2-LW8-D	1/2"NPT阴螺纹 female	共面法兰 coplanar flange	1/4"NPT阴螺纹female

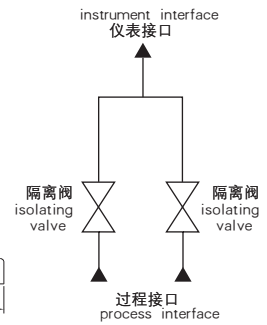
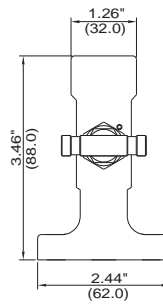
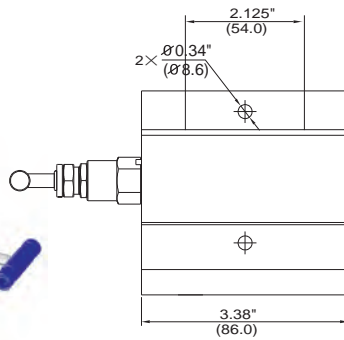

基本订货号 Order information	入口/过程接口 inlet/process interface	出口/仪表 outlet/instrument	测试口/泄放口 measuring port/drainage port
-JFG2F-LW4-D	1/4"NPT阴螺纹female	标准法兰standard flange	1/4"NPT阴螺纹female
-JFG2F-LW6-D	3/8"NPT阴螺纹female	标准法兰standard flange	3/8"NPT阴螺纹female
-JFG2F-LW8-D	1/2"NPT阴螺纹female	标准法兰standard flange	1/2"NPT阴螺纹female
-JFG2F-LW12-D	3/4"NPT阴螺纹female	标准法兰standard flange	3/4"NPT阴螺纹female
-JFG2F-LW16-D	1"NPT阴螺纹female	标准法兰standard flange	1"NPT阴螺纹female
-JFG2F-LW24-D	1 1/2"NPT阴螺纹female	标准法兰standard flange	1 1/2"NPT阴螺纹female

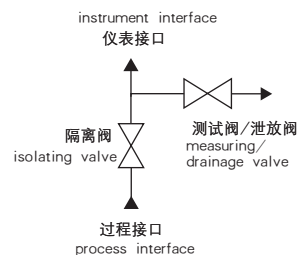
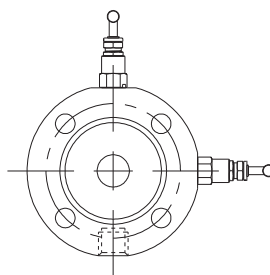
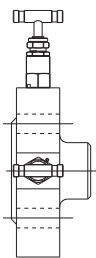

3阀组 valve manifolds

基本订货号 Order information	入口/过程接口 inlet/process interface	出口/仪表 outlet/instrument	测试口/泄放口 measuring port/drainage port
-JFG3A1-LW8-R	1/2"NPT阴螺纹female	1/2"NPT阴螺纹female	选项selection
-JFG3A2-SK8-R	1/2"XYG-SK (LOK)	1/2"XYG-SK (LOK)	选项selection

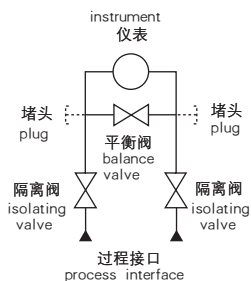
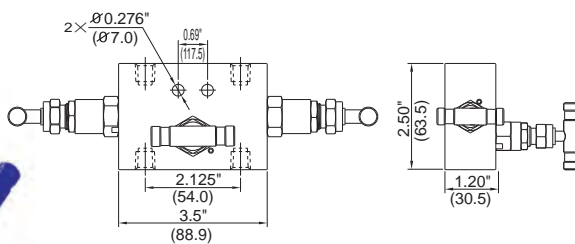

XYF-JFG系列仪表阀组

XYF — JFGseries Instrument Manifolds

基本订货号 Order information	入口/过程接口 inlet/process interface	出口/仪表 outlet/instrument	测试口/泄放口 measuring port/drainage port
-JFG3A3-LW8-R	1/2"XYG-SK (LOK)	1/2"XYG-SK (LOK)	选项selection
-JFG3A4-GH12mm-R	Φ12mmXYG-GH	Φ12mmXYG-GH	选项selection

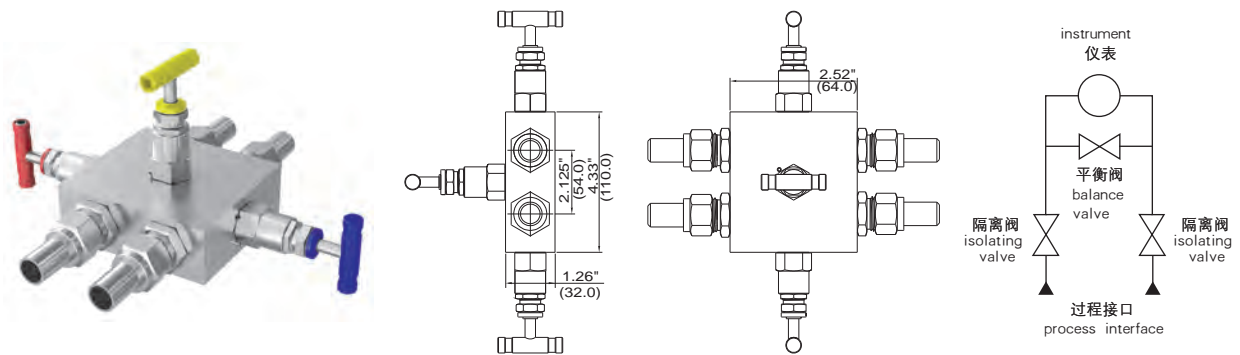

基本订货号 Order information	入口/过程接口 inlet/process interface	出口/仪表 outlet/instrument
-JFG3B1-LW8-D	1/2"NPT阴螺纹female	共面法兰coplanar flange
-JFG3B2-SK6-D	3/8"XYG-SK (LOK)	共面法兰coplanar flange

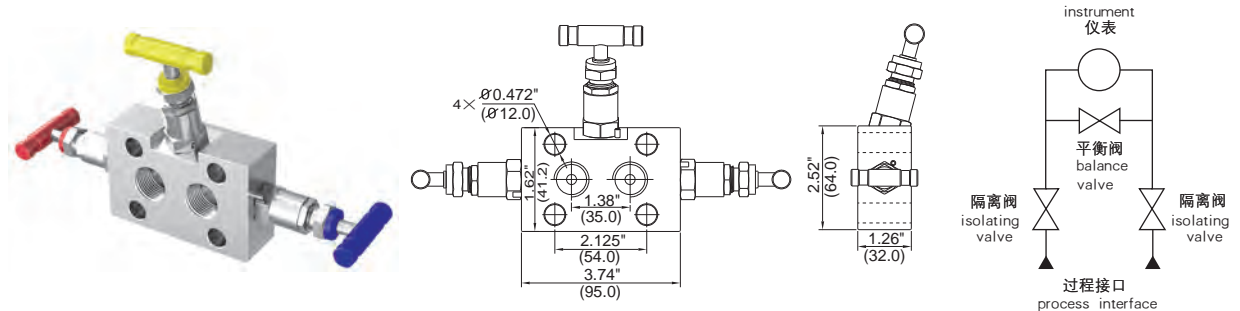

配有2个聚四氟乙烯密封环和4个7/16"UNF高强度螺栓

Two PTFE sealing ring and four 7/16" UNF bolts with high strength are supplied accordingly.

扬中新亚自控工程有限公司

YANGZHONG SINYA AUTO-CONTROL ENGINEERING CO.,LTD.

基本订货号 Order information	入口/过程接口 inlet/process interface	出口/仪表 outlet/instrument
-JFG3B3-LW8-D	1/2"NPT 阴螺纹 female	共面法兰 coplanar flange
-JFG3B4-SK6-D	3/8"XYG-SK (LOK)	共面法兰 coplanar flange

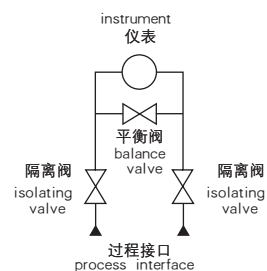
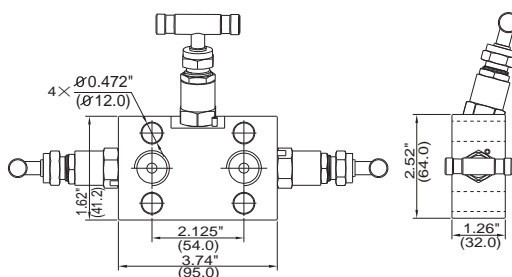

特殊出口位置的三阀组3-valve manifold on special outlet position.

配有4个7/16"UNF高强度螺栓, 不配置聚四氟乙烯密封环

4 bolts of 7/16"UNF with high strength would be supplied accordingly. There is no PTFE sealing ring supplied.

基本订货号 Order information	入口/过程接口 inlet/process interface	出口/仪表 outlet/instrument	测试口/泄放口 measuring port/drainage port
-JFG3C1-LW8-D	1/2"NPT 阴螺纹 female	共面法兰 coplanar flange	选项 selection
-JFG3C2-SK8-D	1/2"XYG-SK (LOK)	共面法兰 coplanar flange	选项 selection

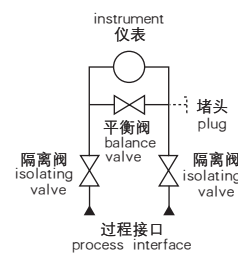
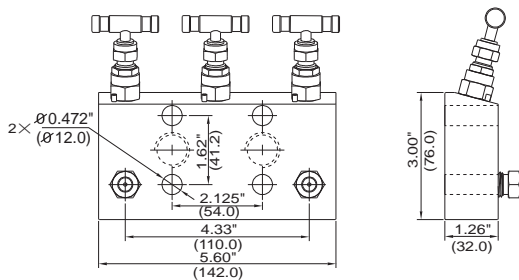

配有2个聚四氟乙烯密封环和4个7/16"UNF高强度螺栓

Two PTFE sealing ring and four 7/16" UNF bolts with high strength are supplied accordingly.

基本订货号 Order information	入口/过程接口 inlet/process interface	出口/仪表 outlet/instrument	测试口/泄放口 measuring port/drainage port
-JFG3T-LW8-D	1/2"NPT 阴螺纹 female	共面法兰 coplanar flange	1/4"NPT 阴螺纹 female

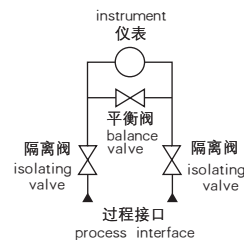
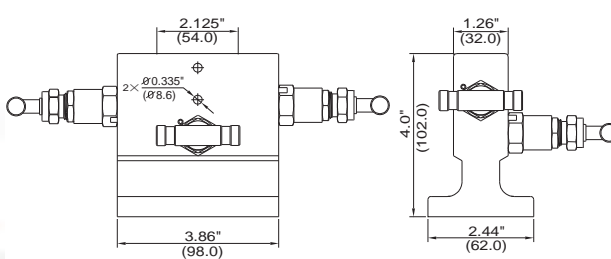

XYF-JFG系列仪表阀组



XYF — JFGseries Instrument Manifolds

基本订货号 Order information	入口/过程接口 inlet/process interface	出口/仪表 outlet/instrument	测试口/泄放口 measuring port/drainage port
-JFG3G-FG-D	共面法兰coplanar flange	共面法兰coplanar flange	1/4"NPT阴螺纹female

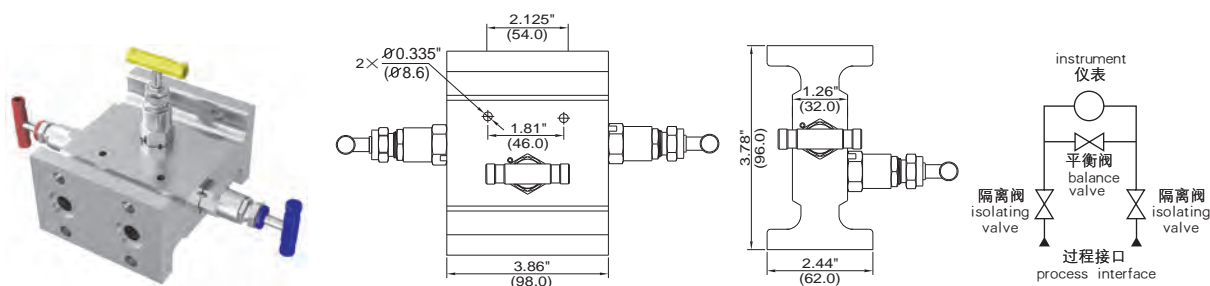

5阀组 valve manifolds

基本订货号 Order information	入口/过程接口 inlet/process interface	出口/仪表 outlet/instrument	测试口/泄放口 measuring port/drainage port
-JFG5A1-LW8-R	1/2"NPT阴螺纹female	1/2"NPT阴螺纹female	1/4"NPT阴螺纹female

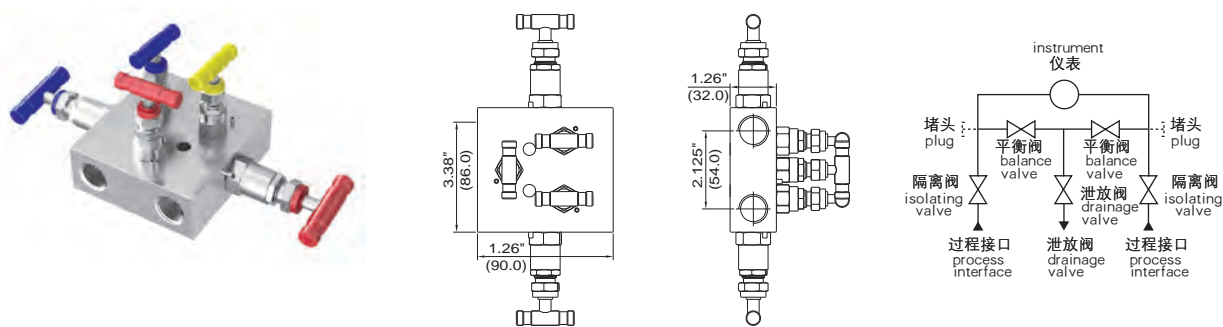

基本订货号 Order information	入口/过程接口 inlet/process interface	出口/仪表 outlet/instrument	测试口/泄放口 measuring port/drainage port
-JFG5A2-SK8-R	1/2"XYG-SK (LOK)	1/2"XYG-SK (LOK)	1/4"NPT阴螺纹female

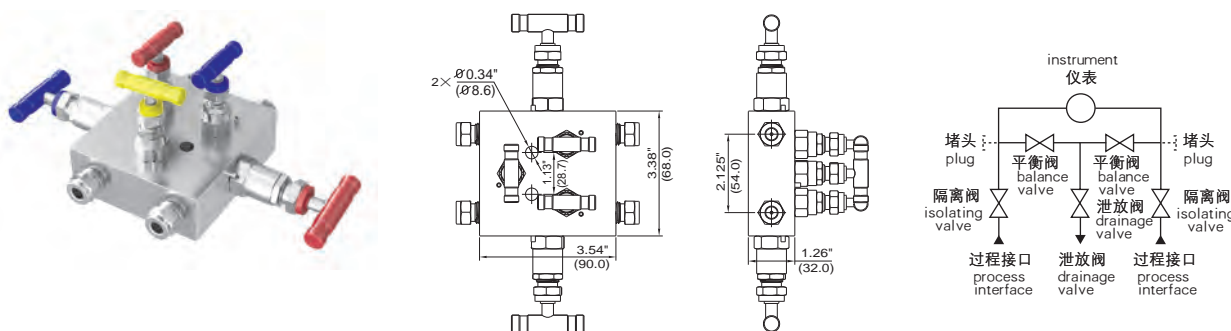

扬中新亚自控工程有限公司

YANGZHONG SINYA AUTO-CONTROL ENGINEERING CO.,LTD.

基本订货号 Order information	入口/过程接口 inlet/process interface	出口/仪表 outlet/instrument	测试口/泄放口 measuring port/drainage port
-JFG5C1-LW8-D	1/2NPT 阴螺纹 female	共面法兰 coplanar flange	1/4"NPT 阴螺纹 female
-JFG5C1-SK8-D	1/2"XYG-SK (LOK)	共面法兰 coplanar flange	1/4"NPT 阴螺纹 female

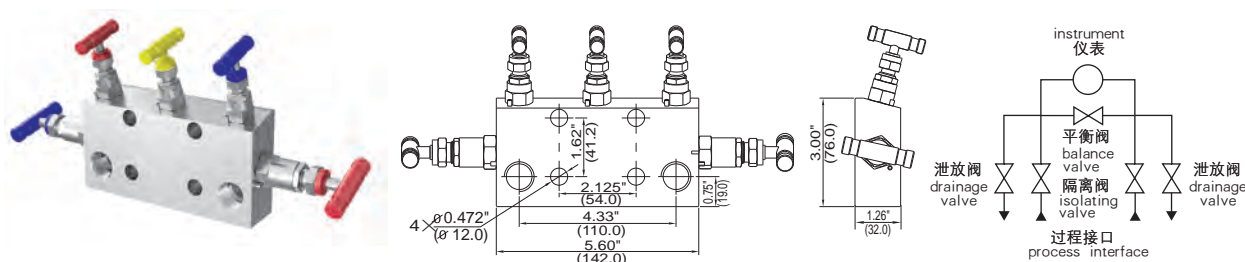

配有2个聚四氟乙烯密封环和4个7/16" UNF高强度螺栓
Two PTFE sealing ring and four 7/16" UNF bolts with high strength are supplied accordingly.

基本订货号 Order information	入口/过程接口 inlet/process interface	出口/仪表 outlet/instrument	测试口/泄放口 measuring port/drainage port
-JFG5C2-LW8-R	1/2NPT 阴螺纹 female	1/2NPT 阴螺纹 female	1/4"NPT 阴螺纹 female
-JFG5C2-SK8-R	1/2"XYG-SK (LOK)	1/2NPT 阴螺纹 female	1/4"NPT 阴螺纹 female

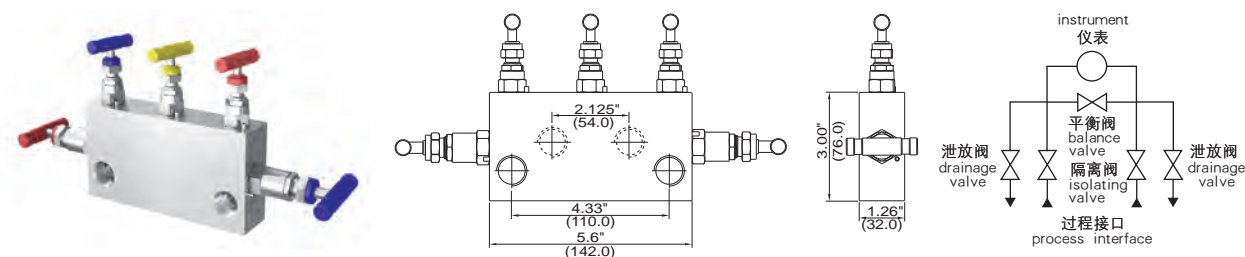

基本订货号 Order information	入口/过程接口 inlet/process interface	出口/仪表 outlet/instrument	泄放口 measuring port/drainage port	测试口 measuring port/drainage port
-JFG5C3-LW8-D	1/2NPT 阴螺纹 female	共面法兰 coplanar flange	1/4"NPT 阴螺纹 female	选项 selection
-JFG5C3-SK8-D	1/2"XYG-SK (LOK)	共面法兰 coplanar flange	1/4"NPT 阴螺纹 female	选项 selection

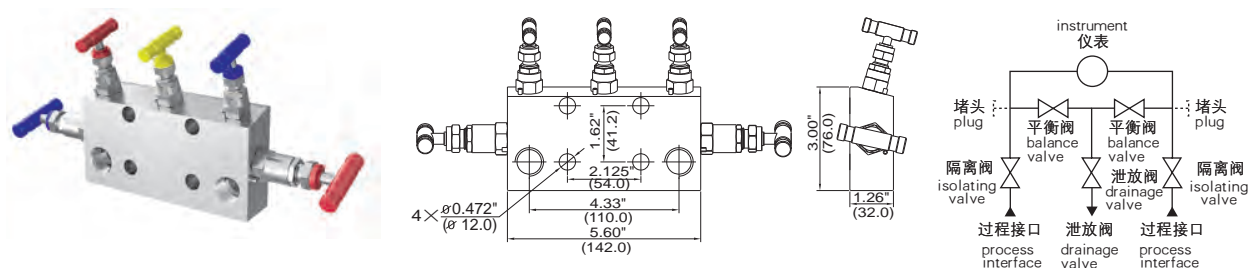

配有2个聚四氟乙烯密封环和4个7/16" UNF高强度螺栓
Two PTFE sealing ring and four 7/16" UNF bolts with high strength are supplied accordingly.

XYF-JFG系列仪表阀组



XYF — JFGseries Instrument Manifolds

基本订货号 Order information	入口/过程接口 inlet/process interface	出口/仪表 outlet/instrument	泄放口 measuring port/drainage port	测试口 measuring port/drainage port
-JFG5C4-LW8-R	1/2NPT 阴螺纹 female	1/2NPT 阴螺纹 female	1/4"NPT 阴螺纹 female	1/4"NPT 阴螺纹 female
-JFG5C4-SK8-R	1/2"XYG-SK (LOK)	1/2NPT 阴螺纹 female	1/4"NPT 阴螺纹 female	1/4"NPT 阴螺纹 female

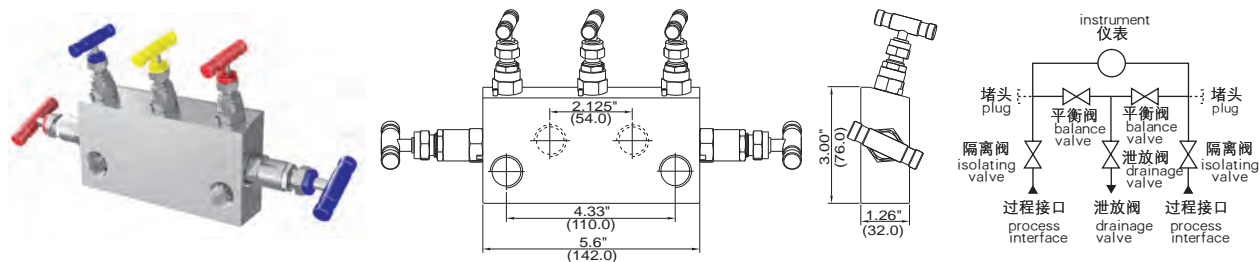

基本订货号 Order information	入口/过程接口 inlet/process interface	出口/仪表 outlet/instrument	测试口/泄放口 measuring port/drainage port
-JFG5T1-LW8-D	1/2NPT 阴螺纹 female	共面法兰 coplanar flange	选项 selection
-JFG5T1-SK12mm-D	Φ12mm	Φ12mm	选项 selection

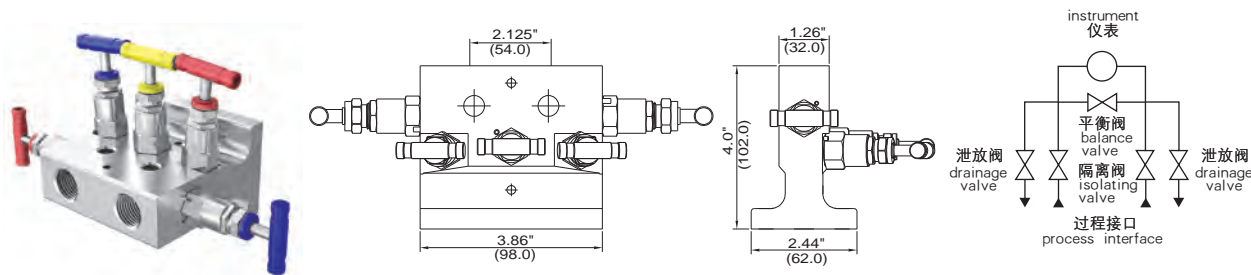

基本订货号 Order information	入口/过程接口 inlet/process interface	出口/仪表 outlet/instrument	测试口/泄放口 measuring port/drainage port
-JFG5G-FG-D	1/2NPT 阴螺纹 female	1/2NPT 阴螺纹 female	选项 selection

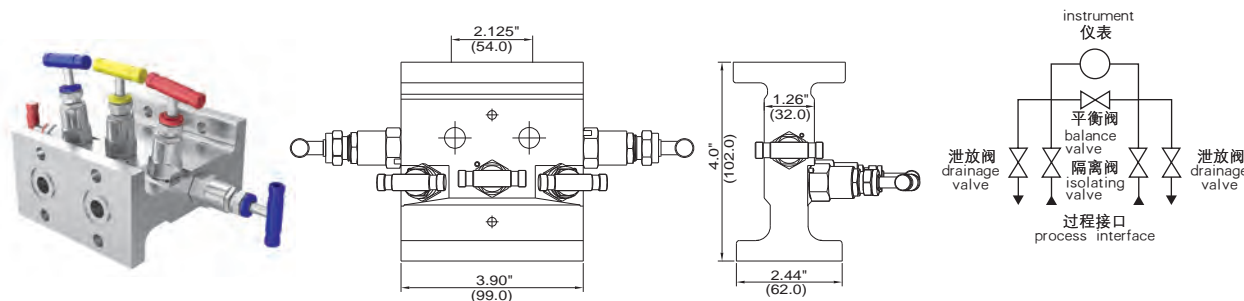

SINYA

港商 扬中新亚自控工程有限公司
独资 YANGZHONG SINYA AUTO-CONTROL ENGINEERING CO., LTD.

地址：江苏省扬中经济开发区兴隆港北路

Add: Xinglong Port, Yangzhong, Zhenjiang, Jiangsu, China

电话(Tel): 0511-88783806

传真(Fax): 0511-88451691

网址(Http): www.sklok.com

邮箱(E-mail): sales@sklok.com info@sklok.com